

SPECIFICATIONS FOR SPIT BRAAIS

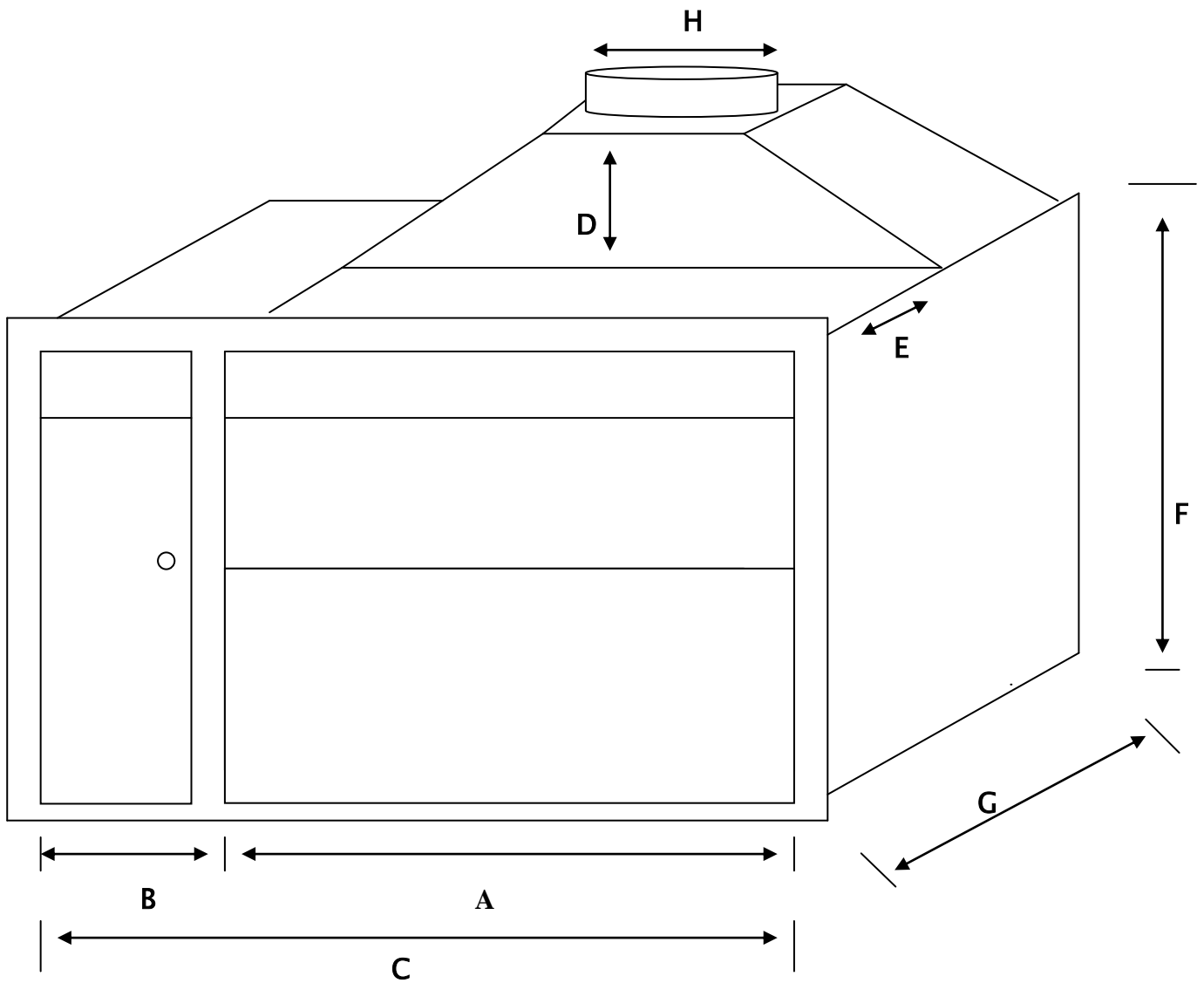

PRODUCT	A	B	C	D	E	F	G	H
	MEASUREMENTS GIVEN IN MILLIMETRES							
1200	1200	440	1640	250	230	825	640	350 Ø
1500	1500	440	1940	300	170	925	695	450 Ø